

# LVT/LVP Flooring Profiles

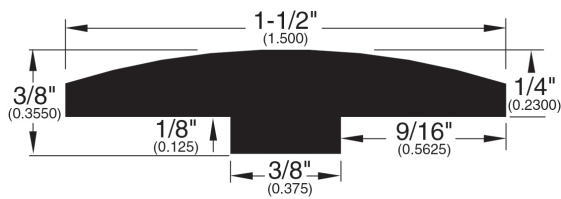

**T-Mold (702)**

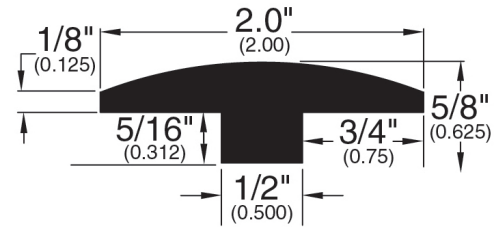

**T-Mold (002)**

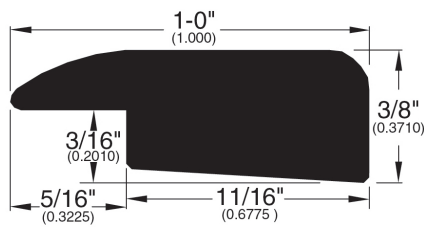

**Square Nose (243)**

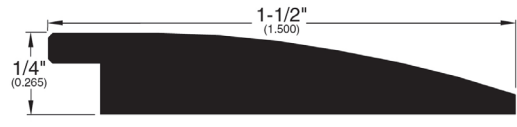

**Reducer (022)**

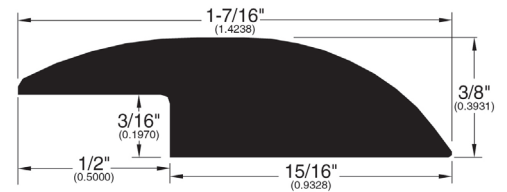

**Reducer Overlap (329)**

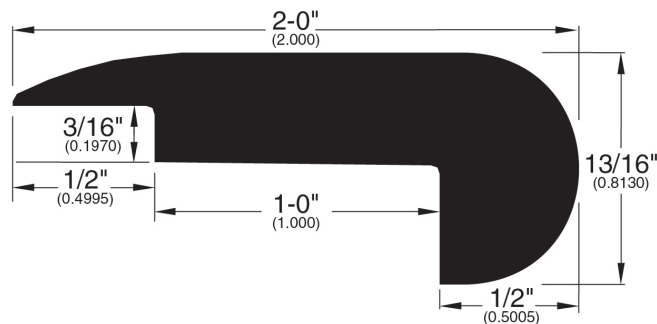

**Stair Nose Overlap (330)**

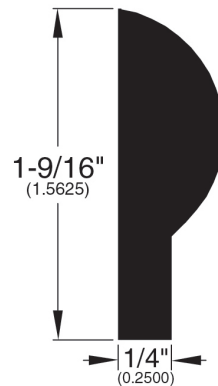

**Stair Nose Adjustable (058)**

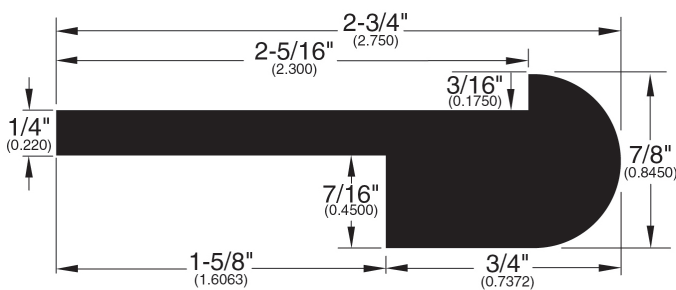

**Stair Nose (121)**

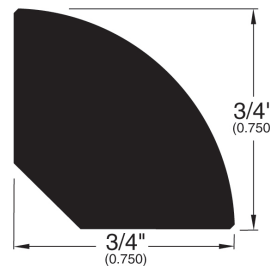

**Quarter Round (001)**

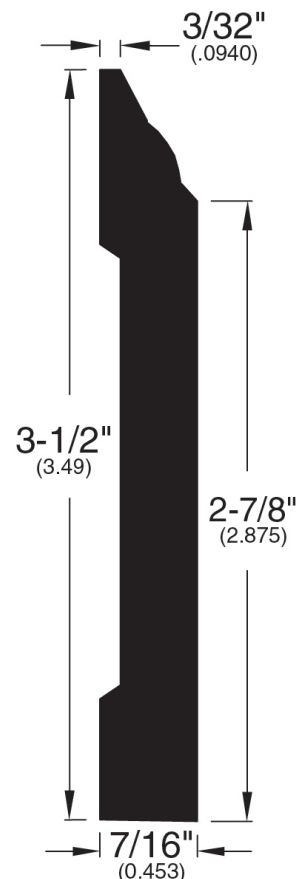

**Wall Base (003)**

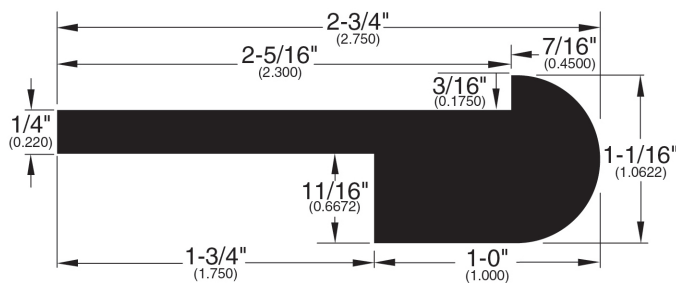

**Stair Nose (161)**

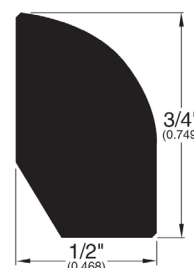

**Base Shoe (024)**